

How to lay out a web page with CSS

You can use table design features in Adobe Dreamweaver CS3 to create a simple page layout. However, a more powerful technique is to use Cascading Style Sheets (CSS). The basic building block of CSS layout is the *div* tag—an HTML tag that in most cases acts as a rectangular container for text, images, and other page elements. When you create a CSS layout, you place *div* tags (or *divs*) on the page, add content to them, and position them in various places. Unlike table cells, which are restricted to existing somewhere within the rows and columns of a table, *divs* can appear anywhere on a web page. You can position *divs* *absolutely* (by specifying x- and y-coordinates), or *relatively* (by specifying their distance from other page elements).

In Dreamweaver, you can quickly and easily place an AP *div* (short for *absolutely positioned div tags*). These elements provide great control over the page layout, reduce the amount of code you need, and enable you to format layout blocks with margins, borders, and colors. In addition, people using screen readers to view web pages have a much easier time browsing pages built with CSS because the code is simpler and shorter. The limitation of an AP *div*, however, is that since it is absolutely positioned, its position never adjusts on the page to accommodate to the size of the browser window.

You will learn more about CSS in later units.

Create a new page

1. Start Dreamweaver.
2. Make sure the Files panel is visible (**Figure 1**). In Windows, it is docked at the right side of the screen. If the Files panel is not open, select Window > Files.
3. Make sure your portfolio site is selected. If it is not, click the Site pop-up menu and select your portfolio site.
4. Select File > New.

The New Document dialog box opens (**Figure 2**).

5. With the Blank Page category selected under Page Type, click HTML.
6. Click Create.

A new untitled HTML document opens.

7. To save the untitled document as your home page, select File > Save As.

The Save As dialog box opens to the root folder of your portfolio site automatically.

8. Name the new page index.html and click Save.

The new file, index.html, is added to the root folder in the Files panel (**Figure 3**).

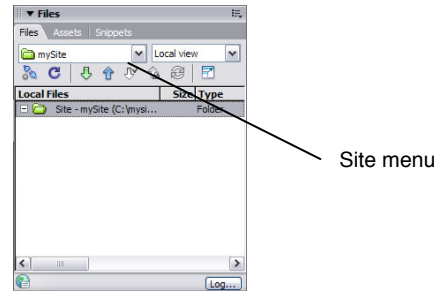

Figure 1 Files panel

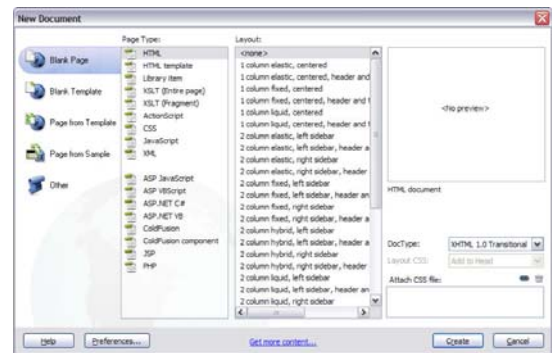

Figure 2 The New Document dialog box

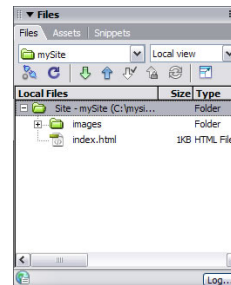

Figure 3 Files panel showing index.html

Insert a div tag

1. Select the Layout category in the Insert bar.
Make sure the Standard mode button is selected (**Figure 4**).
2. Click the Draw AP Div button (**Figure 4**).
The mouse pointer changes to a cross when you move it over the page.
3. Select one of the page areas on your storyboard. To create the div that will define this area on your page, drag a rectangle in the Dreamweaver document. When the rectangle matches the page area's size on your storyboard, release the mouse button.
Make sure not to click on the page again. You want to leave the new div selected (**Figure 5**). If you need to reselect the div, click its border.
4. Make sure the Property inspector is open (**Figure 6**). In Windows, it is docked at the bottom of the screen. If the Property inspector is not open, select Window > Properties.
5. In the CSS-P Element ID box, enter a name for the div.
Choose a unique name that will help you remember the div's contents, such as *header* or *navigation*.
Note: "CSS-P" is a commonly accepted abbreviation for "CSS Positioning".
6. Click the Bg color box and select a color in the color picker.
The div changes to the selected color.
7. Open the AP Elements panel (Window > AP Elements).
You'll see that Dreamweaver has added the new div to the list of AP Elements.
8. Click once outside the new div to deselect it.
A thin black line appears around the div. This line does not appear in a browser. If you do not see the line, select View > Visual Aids > CSS Layout Outlines.
9. Continue adding divs for all the sections on your storyboard. You can place divs directly alongside one another (**Figure 7**).
10. Save your page.

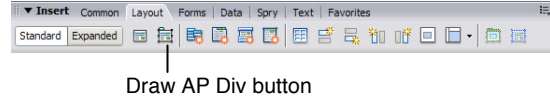

Figure 4 Insert bar, Layout category

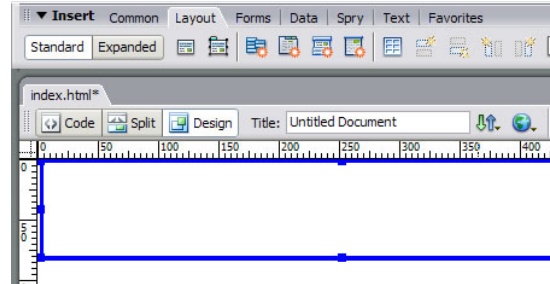

Figure 5 Div inserted and selected

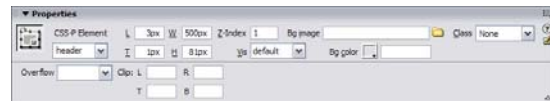
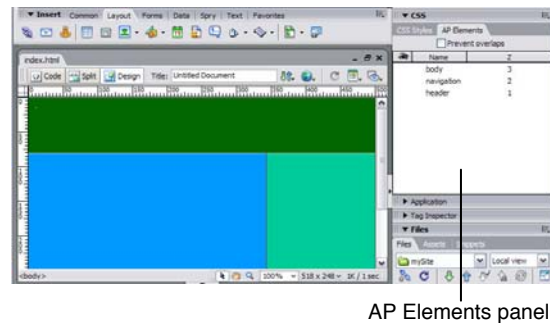

Figure 6 CSS-P Element ID Property inspector



AP Elements panel

Figure 7 Multiple divs on page

Resize divs

You can resize an individual div or simultaneously resize multiple divs to make them the same width and height.

Note: If the Prevent Overlaps option is selected in the AP Elements panel, you will not be able to resize a div so it overlaps with another div.

1. Select a div by clicking its border or by clicking the div's name in the AP Elements panel.
2. Do one of the following to resize the div:
 - To resize by dragging, drag any of the div's resize handles (**Figure 8**).
 - To resize one pixel at a time, hold down Control (Windows) or Option (Mac OS) while pressing an arrow key.

Note: The arrow keys move the right and bottom borders of the div; you can't resize the top and left borders with this technique.

- In the Property inspector, type values for width (W) and height (H).

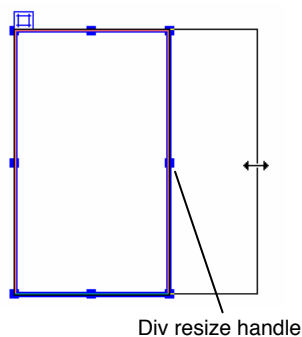

Figure 8 Resize by dragging

Move divs

You can move divs in Design view in much the same way you move objects in most basic graphics applications.

To move one or more selected divs:

1. Select one or more divs.
2. Do one of the following:
 - To move by dragging, drag the div's selection handle (**Figure 9**).
 - To move one pixel at a time, use the arrow keys.

Note: If the Prevent Overlaps option is selected in the AP Elements panel, you will not be able to move a div so that it overlaps another div.

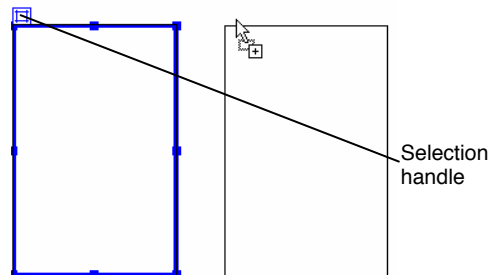

Figure 9 Moving a div

Add content to divs

You can add images, text, and other content (such as Flash movies) to your divs just as you would elsewhere in a web page.

1. To insert an image in a div, click in the div and select Insert > Image on the menu bar.

Note: Make sure the div is sized large enough to hold the image or other content. If the div is sized smaller than the image, the div may not display correctly in all browsers.
2. In the Select Image Source dialog box, locate and select an image to insert (such as your page banner). Then click OK (Windows) or Choose (Mac OS).

The image appears on the div (**Figure 10**).

3. To format the image in the div, select the image and select formatting elements in the Property inspector.
4. To add text to a div, click in the div and type text or paste text copied from another document.
5. To format text, select the text and select formatting elements in the Property inspector, such as font, alignment, and size of the text.

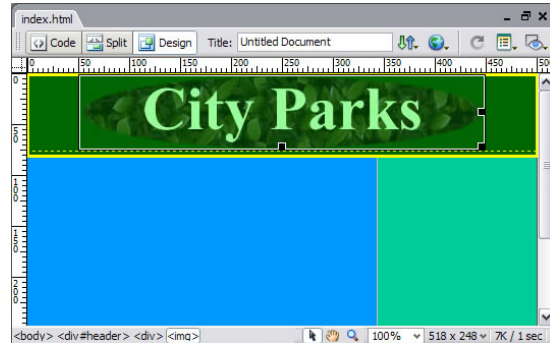

Figure 10 Div with image added

Preview a page

You can add images, text, and other content (such as Flash movies) to your divs just as you would elsewhere in a web page.

To preview the page in a browser (**Figure 11**), select File > Preview In Browser and then select a browser from the submenu (or press F12).

Note: It is important to preview in a browser to make sure your design fits in a standard browser window. Try resizing the browser window to see the effect on your page.

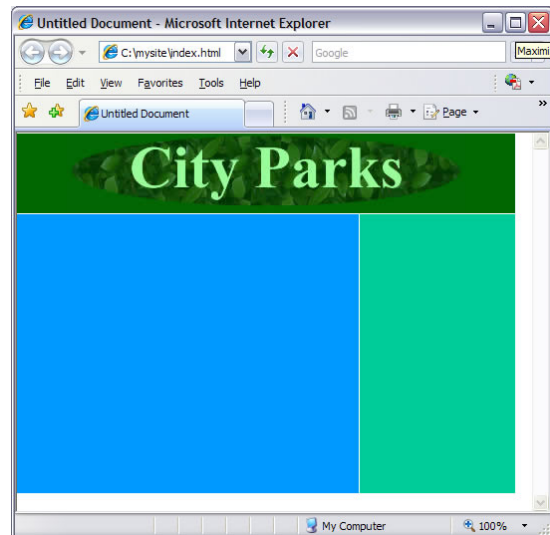

Figure 11 Web page in browser